

10MHz, Rail-to-Rail Input and Output Op Amp in SOT-23

FEATURES

- Rail-to-Rail Input and Output
- Small SOT-23 Package
- Gain Bandwidth Product: 10MHz
- -40°C to 85°C Operation
- Slew Rate: 2.25V/μs
- Low Input Offset Voltage: 1.5mV Max
- High Output Current: 25mA Min
- Specified on 3V, 5V and ±5V Supplies
- High Voltage Gain: 1000V/mV 10k Load
- High CMRR: 88dB Min
- High PSRR: 80dB Min
- Input Bias Current: 300nA Max
- Input Offset Current: 25nA Max

APPLICATIONS

- Portable Instrumentation
- Rail-to-Rail Buffer Amplifiers
- Low Voltage Signal Processing
- Driving A/D Converters
- Battery-Powered Systems

DESCRIPTION

The LT[®]1797 is a unity-gain stable 10MHz op amp available in the small SOT-23 package that operates on all single and split supplies with a total voltage of 2.7V to 12V. The amplifier draws 1mA of quiescent current and has a slew rate of 2.25V/μs.

The input common mode range of the LT1797 includes both rails, making it ideal for current sensing applications. The input stage incorporates phase reversal protection to prevent false outputs from occurring when the inputs are driven beyond the supplies. Protective resistors are included in the input leads so that current does not become excessive when the inputs are forced above or below the supplies.

The output of the LT1797 can swing to within 50mV of V⁺ and 8mV of V⁻ without drawing excess current in either condition. The amplifier can drive loads up to 25mA and still maintain rail-to-rail capability.

The LT1797 op amp is available in the space saving 5-lead SOT-23 package.

 LTC and LT are registered trademarks of Linear Technology Corporation.

TYPICAL APPLICATION

Fast Compact -48V Current Sense

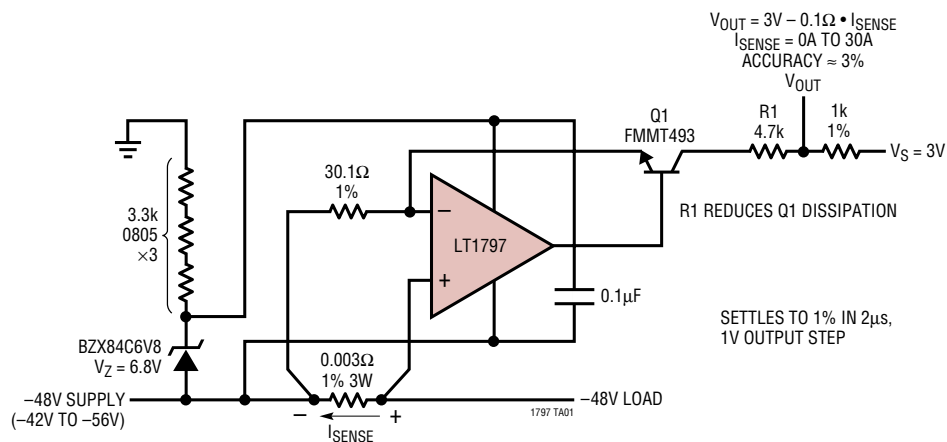

ABSOLUTE MAXIMUM RATINGS

(Note 1)

| | |
|---|--|
| Total Supply Voltage (V^+ to V^-) | 12.6V |
| Input Differential Voltage | 12.6V |
| Input Current | $\pm 10\text{mA}$ |
| Output Short-Circuit Duration (Note 2) | Continuous |
| Operating Temperature Range | |
| (Note 3) | -40°C to 85°C |
| Specified Temperature Range | -40°C to 85°C |
| Junction Temperature | 150°C |
| Storage Temperature Range | -65°C to 150°C |
| Lead Temperature (Soldering, 10 sec) | 300°C |

PACKAGE/ORDER INFORMATION

| | |
|---|------------------------|
| <p>S5 PACKAGE 5-LEAD PLASTIC SOT-23 $T_{JMAX} = 150^\circ\text{C}$, $\theta_{JA} = 250^\circ\text{C/W}$</p> | ORDER PART NUMBER |
| | LT1797CS5 LT1797IS5 |
| | S5 PART MARKING |
| | LTLM LTTL |

Consult factory for parts specified with wider operating temperature ranges.

ELECTRICAL CHARACTERISTICS

The ● denotes specifications which apply over the specified temperature range, otherwise specifications are $T_A = 25^\circ\text{C}$.
 $V_S = 3\text{V}$, 0V ; $V_S = 5\text{V}$, 0V , $V_{CM} = V_{OUT} = \text{half supply}$, pulse power tested, unless otherwise specified. (Note 3)

| SYMBOL | PARAMETER | CONDITIONS | MIN | TYP | MAX | UNITS |
|-----------|-------------------------------------|---|-----|------|-------|------------------------------|
| V_{OS} | Input Offset Voltage | $0^\circ\text{C} \leq T_A \leq 70^\circ\text{C}$ | ● | 1 | 1.5 | mV |
| | | $-40^\circ\text{C} \leq T_A \leq 85^\circ\text{C}$ | ● | | 2.5 | mV |
| | | | | | 3.0 | mV |
| | Input Offset Voltage Drift (Note 4) | | ● | 5 | 20 | $\mu\text{V}/^\circ\text{C}$ |
| I_B | Input Bias Current | $V_{CM} = V^-$ | ● | -300 | -150 | nA |
| | | $V_{CM} = V^+$ | ● | | 50 | 100 |
| | Input Bias Current Drift | | ● | 0.1 | | $\text{nA}/^\circ\text{C}$ |
| I_{OS} | Input Offset Current | $V_{CM} = V^-$ | ● | 10 | 25 | nA |
| | | $V_{CM} = V^+$ | ● | 10 | 25 | nA |
| | Input Noise Voltage | 0.1Hz to 10Hz | | 1.5 | | μV_{p-p} |
| e_n | Input Noise Voltage Density | $f = 10\text{kHz}$ | | 20 | | $\text{nV}/\sqrt{\text{Hz}}$ |
| i_n | Input Noise Current Density | $f = 10\text{kHz}$ | | 0.23 | | $\text{pA}/\sqrt{\text{Hz}}$ |
| | | $f = 10\text{kHz}$, $V_{CM} = V_{CC} - 0.3\text{V}$ | | 0.15 | | $\text{pA}/\sqrt{\text{Hz}}$ |
| R_{IN} | Input Resistance | Differential | | 200 | 330 | $\text{k}\Omega$ |
| | | Common Mode, $V_{CM} = 0\text{V}$ to $V_S - 1.2\text{V}$ | | | 100 | $\text{M}\Omega$ |
| C_{IN} | Input Capacitance | | | 4 | | pF |
| CMRR | Common Mode Rejection Ratio | $V_{CM} = 0\text{V}$ to $V_S - 1.2\text{V}$ | ● | 88 | 96 | dB |
| | | $V_{CM} = 0\text{V}$ to V_S | ● | 64 | 72 | dB |
| | Input Voltage Range | | ● | 0 | V_S | V |
| A_{VOL} | Large-Signal Voltage Gain | $V_S = 3\text{V}$, $V_O = 0.5\text{V}$ to 2.5V , $R_L = 10\text{k}$ | ● | 200 | 1000 | V/mV |
| | | | ● | 150 | | V/mV |
| | | $V_S = 5\text{V}$, $V_O = 0.5\text{V}$ to 4.5V , $R_L = 10\text{k}$ | ● | 400 | 1000 | V/mV |
| | | | ● | 300 | | V/mV |

ELECTRICAL CHARACTERISTICS

The ● denotes specifications which apply over the specified temperature range, otherwise specifications are $T_A = 25^\circ\text{C}$.
 $V_S = 3\text{V}$, 0V ; $V_S = 5\text{V}$, 0V , $V_{CM} = V_{OUT} = \text{half supply}$, pulse power tested, unless otherwise specified. (Note 3)

| SYMBOL | PARAMETER | CONDITIONS | MIN | TYP | MAX | UNITS |
|----------|---------------------------------|---|-----|--------------|--------------|------------------|
| PSRR | Power Supply Rejection Ratio | $V_S = 2.7\text{V}$ to 12V , $V_{CM} = V_O = 1\text{V}$ | ● | 80 | 90 | dB |
| | Minimum Supply Voltage | | ● | 2.5 | 2.7 | V |
| V_{OL} | Output Voltage Swing LOW | No Load, Input Overdrive = 30mV | ● | 8 | 15 | mV |
| | | $I_{SINK} = 5\text{mA}$ | ● | 80 | 160 | mV |
| | | $I_{SINK} = 10\text{mA}$ | ● | 150 | 250 | mV |
| V_{OH} | Output Voltage Swing HIGH | No Load, Input Overdrive = 30mV | ● | $V_S - 0.14$ | $V_S - 0.05$ | V |
| | | $I_{SOURCE} = 5\text{mA}$ | ● | $V_S - 0.30$ | $V_S - 0.2$ | V |
| | | $I_{SOURCE} = 10\text{mA}$ | ● | $V_S - 0.39$ | $V_S - 0.3$ | V |
| I_{SC} | Short-Circuit Current | $V_S = 5\text{V}$ | | 25 | 45 | mA |
| | | $V_S = 3\text{V}$ | | 15 | 25 | mA |
| I_S | Supply Current | | ● | 1.1 | 1.5 | mA |
| | | | | | 2.0 | mA |
| GBW | Gain Bandwidth Product (Note 5) | $f = 100\text{kHz}$ | ● | 6.0 | 10 | MHz |
| | | $0^\circ\text{C} \leq T_A \leq 70^\circ\text{C}$ | ● | 5.0 | | MHz |
| | | $-40^\circ\text{C} \leq T_A \leq 85^\circ\text{C}$ | ● | 4.5 | | MHz |
| SR | Slew Rate (Note 5) | $A_V = -1$ | ● | 1.3 | 2.25 | V/ μs |
| | | $0^\circ\text{C} \leq T_A \leq 70^\circ\text{C}$ | ● | 1.1 | | V/ μs |
| | | $-40^\circ\text{C} \leq T_A \leq 85^\circ\text{C}$ | ● | 1.0 | | V/ μs |
| t_r | Output Rise Time | 10% to 90%, 0.1V Step, $R_L = 10\text{k}$ | | 55 | | ns |
| t_f | Output Fall Time | 10% to 90%, 0.1V Step, $R_L = 10\text{k}$ | | 55 | | ns |
| t_S | Settling Time | $V_S = 5\text{V}$, $\Delta V_{OUT} = 2\text{V}$ to 0.1%, $A_V = -1$ | | 1.6 | | μs |
| THD | Distortion | $V_S = 3\text{V}$, $V_{OUT} = 1.8V_{P-P}$, $A_V = 1$, $R_L = 10\text{k}$, $f = 1\text{kHz}$ | | 0.001 | | % |
| FPBW | Full-Power Bandwidth (Note 6) | $V_{OUT} = 2V_{P-P}$ | | 360 | | kHz |

The ● denotes specifications which apply over the specified temperature range, otherwise specifications are $T_A = 25^\circ\text{C}$.
 $V_S = \pm 5\text{V}$, $V_{CM} = 0\text{V}$, $V_{OUT} = 0\text{V}$, pulse power tested unless otherwise specified. (Note 3)

| SYMBOL | PARAMETER | CONDITIONS | MIN | TYP | MAX | UNITS |
|----------|-------------------------------------|---|-----|------|------|------------------------------|
| V_{OS} | Input Offset Voltage | $0^\circ\text{C} \leq T_A \leq 70^\circ\text{C}$ | ● | 1 | 1.5 | mV |
| | | $-40^\circ\text{C} \leq T_A \leq 85^\circ\text{C}$ | ● | | 2.5 | mV |
| | | | | | | 3.0 |
| | Input Offset Voltage Drift (Note 4) | | ● | 5 | 20 | $\mu\text{V}/^\circ\text{C}$ |
| I_B | Input Bias Current | $V_{CM} = V^-$ | ● | -300 | -150 | nA |
| | | $V_{CM} = V^+$ | ● | | 50 | 100 |
| | Input Bias Current Drift | | ● | 0.1 | | nA/ $^\circ\text{C}$ |
| I_{OS} | Input Offset Current | $V_{CM} = V^-$ | ● | 10 | 25 | nA |
| | | $V_{CM} = V^+$ | ● | 10 | 25 | nA |
| | Input Noise Voltage | 0.1Hz to 10Hz | | 1 | | μV_{P-P} |
| e_n | Input Noise Voltage Density | $f = 10\text{kHz}$ | | 20 | | nV/ $\sqrt{\text{Hz}}$ |
| i_n | Input Noise Current Density | $f = 10\text{kHz}$ | | 0.23 | | pA/ $\sqrt{\text{Hz}}$ |
| | | $f = 10\text{kHz}$, $V_{CM} = 4.7\text{V}$ | | 0.15 | | pA/ $\sqrt{\text{Hz}}$ |
| R_{IN} | Input Resistance | Differential | | 200 | 330 | k Ω |
| | | Common Mode, $V_{CM} = -5\text{V}$ to 3.8V | | | 100 | M Ω |
| C_{IN} | Input Capacitance | | | 4 | | pF |
| | | Input Voltage Range | ● | -5 | 5 | V |

ELECTRICAL CHARACTERISTICS

The ● denotes specifications which apply over the specified temperature range, otherwise specifications are $T_A = 25^\circ\text{C}$. $V_S = \pm 5\text{V}$, $V_{CM} = 0\text{V}$, $V_{OUT} = 0\text{V}$, pulse power tested unless otherwise specified. (Note 3)

| SYMBOL | PARAMETER | CONDITIONS | MIN | TYP | MAX | UNITS |
|-----------|--------------------------------|---|--------------|-------|-------|------------------|
| CMRR | Common Mode Rejection Ratio | $V_{CM} = -5\text{V to } 3.8\text{V}$ | ● 83 | 96 | | dB |
| | | $V_{CM} = -5\text{V to } 5\text{V}$ | ● 66 | 76 | | dB |
| A_{VOL} | Large-Signal Voltage Gain | $V_O = \pm 4\text{V}$, $R_L = 10\text{k}$ | ● 400 300 | 1000 | | V/mV V/mV |
| V_{OL} | Output Voltage Swing LOW | No Load, Input Overdrive = 30mV | ● | -4.99 | -4.98 | V |
| | | $I_{SINK} = 5\text{mA}$ | ● | -4.92 | -4.87 | V |
| | | $I_{SINK} = 10\text{mA}$ | ● | -4.85 | -4.79 | V |
| V_{OH} | Output Voltage Swing HIGH | No Load, Input Overdrive = 30mV | ● | 4.84 | 4.95 | V |
| | | $I_{SOURCE} = 5\text{mA}$ | ● | 4.70 | 4.80 | V |
| | | $I_{SOURCE} = 10\text{mA}$ | ● | 4.61 | 4.70 | V |
| I_{SC} | Short-Circuit Current (Note 2) | Short to GND | 30 | 50 | | mA |
| PSRR | Power Supply Rejection Ratio | $V_S = \pm 1.35\text{V to } \pm 6\text{V}$ | ● 80 | 90 | | dB |
| I_S | Supply Current | | | 1.40 | 2.25 | mA |
| | | | | | 2.70 | mA |
| GBW | Gain Bandwidth Product | $f = 100\text{kHz}$ | ● 6.5 | 11 | | MHz |
| | | $0^\circ\text{C} \leq T_A \leq 70^\circ\text{C}$ | ● 5.5 | | | MHz |
| | | $-40^\circ\text{C} \leq T_A \leq 85^\circ\text{C}$ | ● 5.0 | | | MHz |
| SR | Slew Rate | $A_V = -1$, $R_L = \infty$, $V_O = \pm 4\text{V}$, Measured at $V_O = \pm 2\text{V}$ | ● 1.50 | 2.50 | | V/ μs |
| | | $0^\circ\text{C} \leq T_A \leq 70^\circ\text{C}$ | ● 1.25 | | | V/ μs |
| | | $-40^\circ\text{C} \leq T_A \leq 85^\circ\text{C}$ | ● 1.10 | | | V/ μs |
| t_r | Output Rise Time | 10% to 90%, 0.1V Step, $R_L = 10\text{k}$ | | 55 | | ns |
| t_f | Output Fall Time | 10% to 90%, 0.1V Step, $R_L = 10\text{k}$ | | 55 | | ns |
| t_S | Settling Time | $\Delta V_{OUT} = 4\text{V to } 0.1\%$, $A_V = 1$ | | 2.6 | | μs |
| FPBW | Full-Power Bandwidth (Note 6) | $V_{OUT} = 8V_{P-P}$ | | 100 | | kHz |

Note 1: Absolute Maximum Ratings are those values beyond which the life of a device may be impaired.

Note 2: A heat sink may be required to keep the junction temperature below absolute maximum.

Note 3: The LT1797C is guaranteed to meet 0°C to 70°C specifications and is designed, characterized and expected to meet the extended temperature limits, but is not tested at -40°C and 85°C . The LT1797I is guaranteed to meet specified performance from -40°C to 85°C .

Note 4: This parameter is not 100% tested.

Note 5: $V_S = 3\text{V}$ limit guaranteed by correlation to 5V tests.

Note 6: Full-power bandwidth is calculated from the slew rate:

$$\text{FPBW} = \text{SR}/2\pi V_P$$

TYPICAL PERFORMANCE CHARACTERISTICS

Supply Current vs Supply Voltage

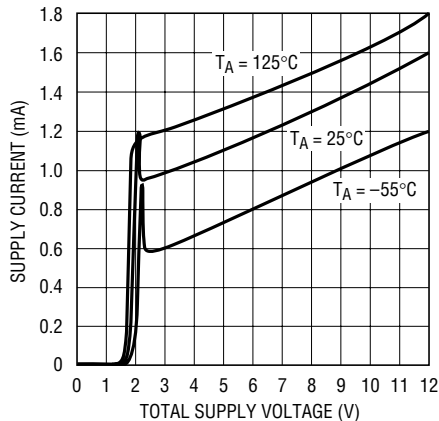

1797 G01

Minimum Supply Voltage

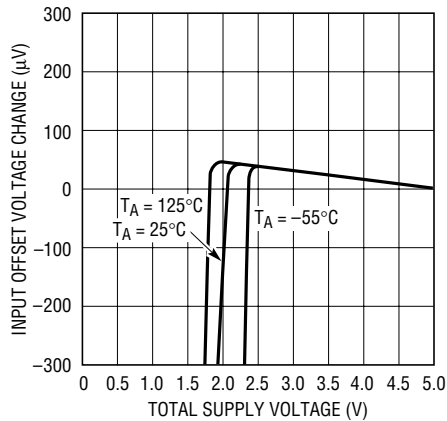

1797 G02

Input Bias Current vs Common Mode Voltage

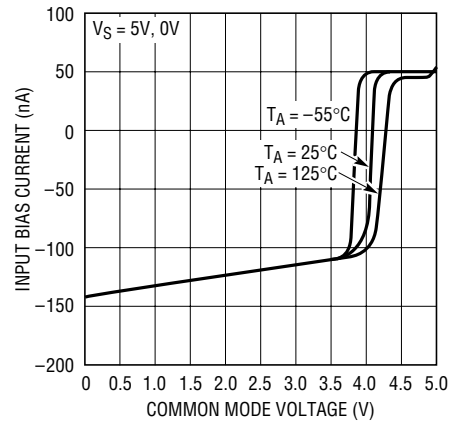

1797 G03

Output Saturation Voltage vs Load Current (Output High)

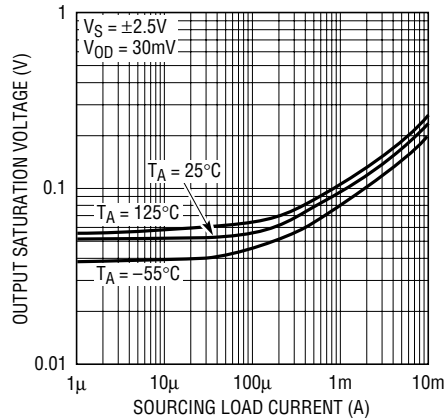

1797 G04

Output Saturation Voltage vs Load Current (Output Low)

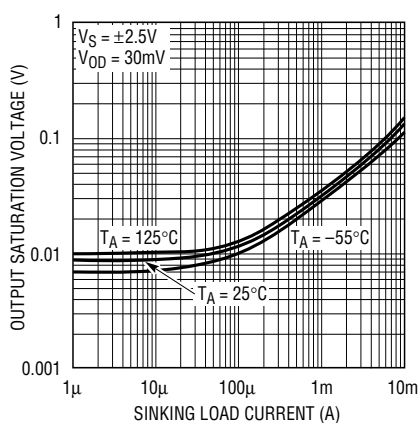

1797 G05

Output Saturation Voltage vs Input Overdrive

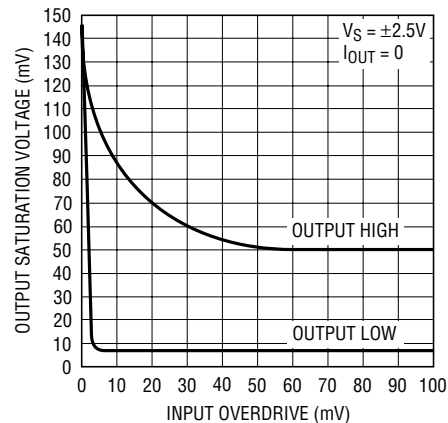

1797 G06

Output Short-Circuit Current vs Temperature

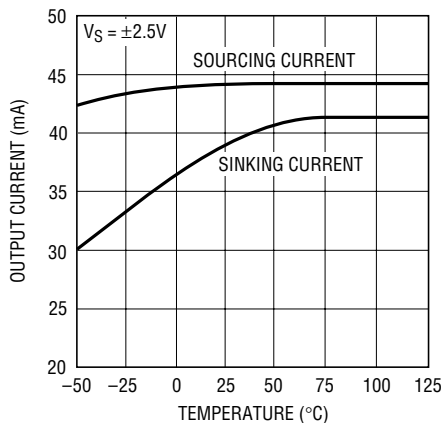

1797 G07

0.1Hz to 10Hz Noise Voltage

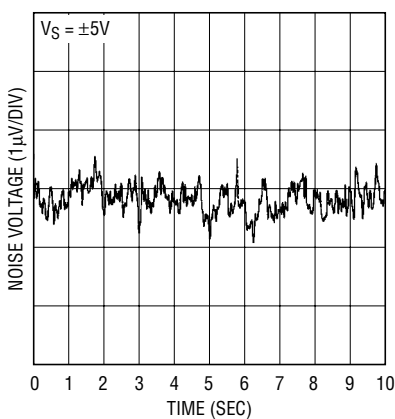

1797 G08

Input Noise Voltage Density vs Frequency

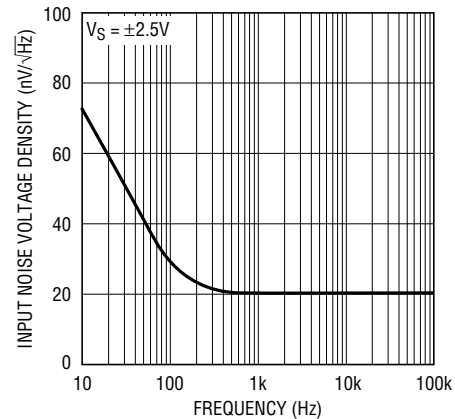

1797 G09

TYPICAL PERFORMANCE CHARACTERISTICS

Input Noise Current Density vs Frequency

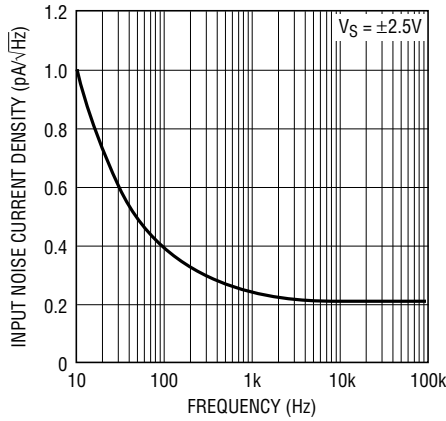

1797 G10

Gain and Phase Shift vs Frequency

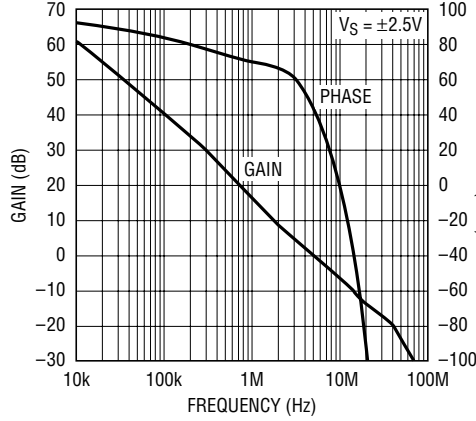

1797 G11

Gain Bandwidth Product vs Temperature

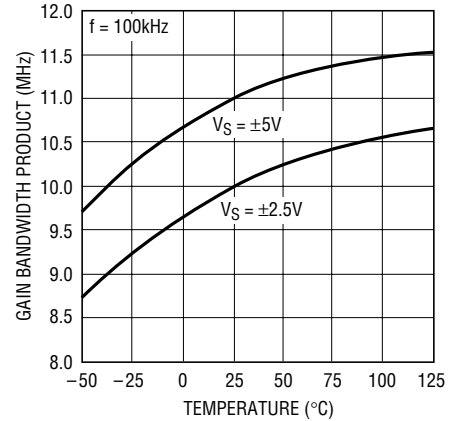

1797 G12

Slew Rate vs Temperature

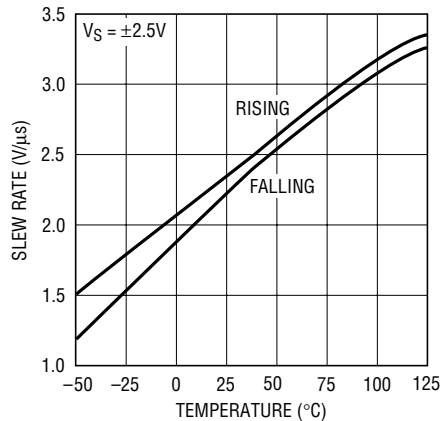

1797 G13

Gain Bandwidth Product and Phase Margin vs Supply Voltage

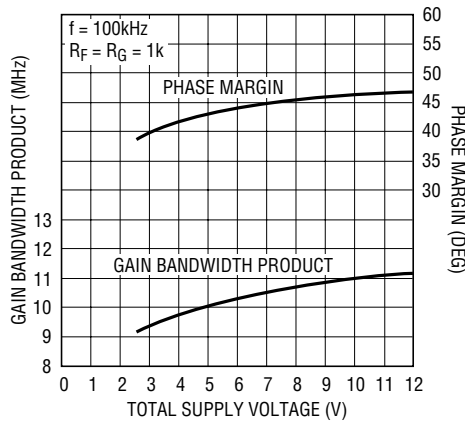

1797 G14

Gain Bandwidth Product and Phase Margin vs R_F and R_G

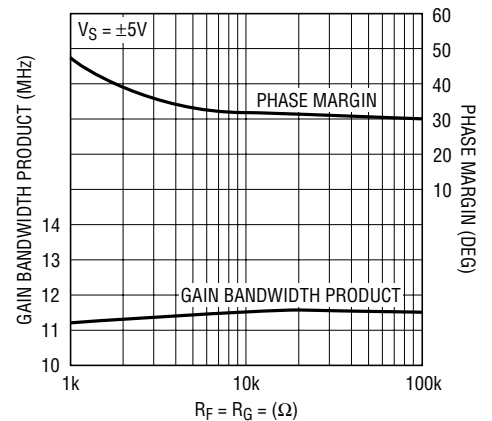

1797 G15

PSRR vs Frequency

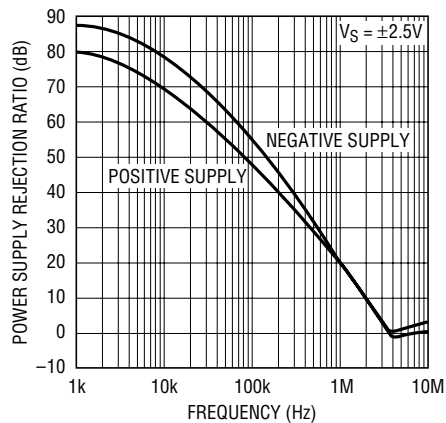

1797 G16

CMRR vs Frequency

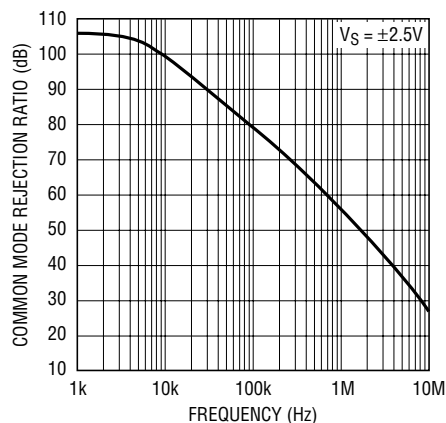

1797 G17

Output Impedance vs Frequency

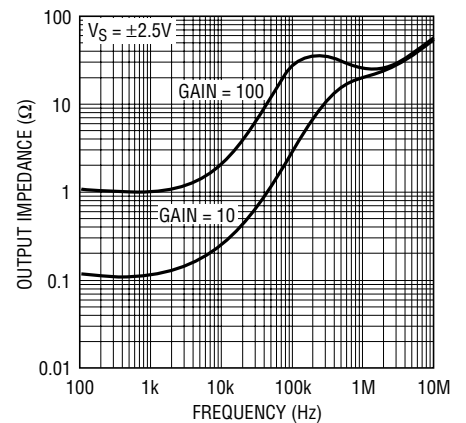

1797 G18

TYPICAL PERFORMANCE CHARACTERISTICS

Open-Loop Gain

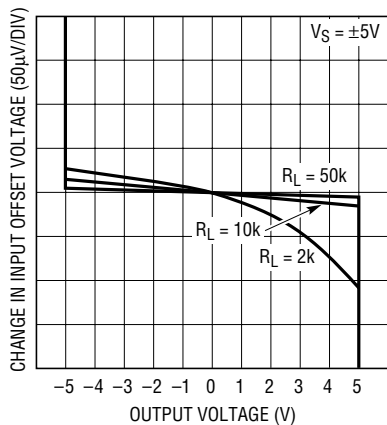

1797 G19

Settling Time to 0.1% vs Output Step

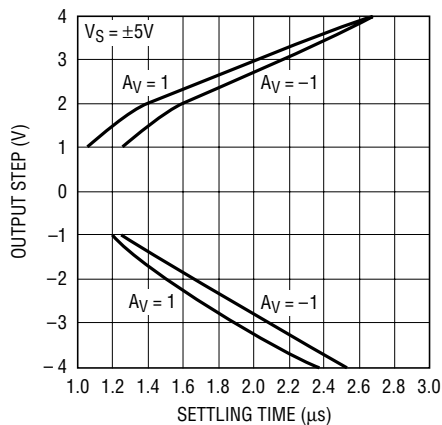

1797 G20

Capacitive Load Handling Overshoot vs Capacitive Load

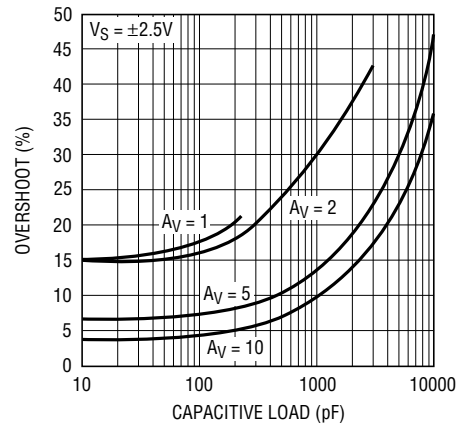

1797 G21

Undistorted Output Swing vs Frequency

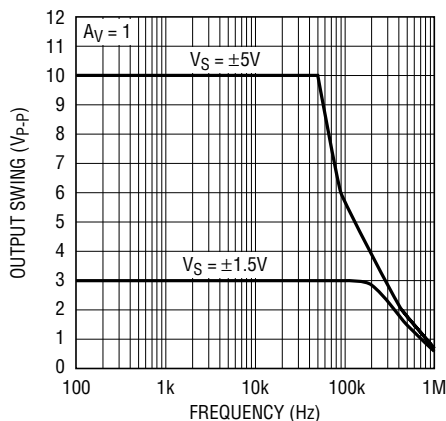

1797 G22

Total Harmonic Distortion + Noise vs Frequency

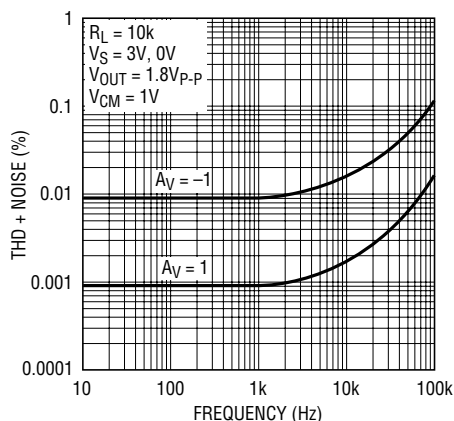

1797 G23

Total Harmonic Distortion + Noise vs Load Resistance

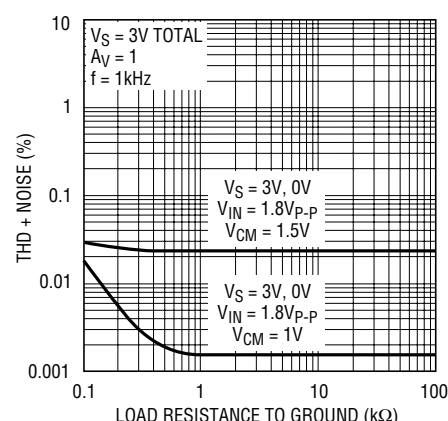

1797 G24

Total Harmonic Distortion + Noise vs Output Voltage Amplitude

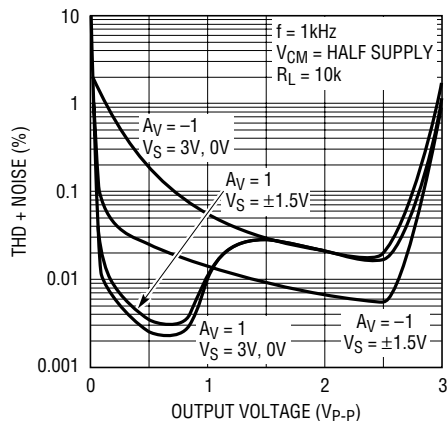

1797 G25

Large-Signal Response

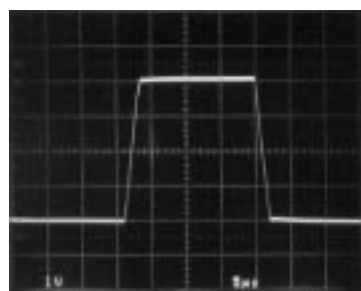

1797 G26

Small-Signal Response



1797 G27

APPLICATIONS INFORMATION

Supply Voltage

The positive supply pin of the LT1797 should be bypassed with a small capacitor (about 0.1 μ F) within an inch of the pin. When driving heavy loads an additional 4.7 μ F electrolytic capacitor should be used. When using split supplies the same is true for the negative supply pin.

Inputs

The LT1797 is fully functional for an input signal range from the negative supply to the positive supply. Figure 1 shows a simplified schematic of the amplifier. The input stage consists of two differential amplifiers, a PNP stage Q3/Q4 and an NPN stage Q1/Q2 that are active over different ranges of input common mode voltage. The PNP differential pair is active for input common mode voltages V_{CM} between the negative supply to approximately 1.2V below the positive supply. As V_{CM} moves closer toward the positive supply, the transistor QB1 will steer the tail current I1 to the current mirror Q5/Q6, activating the NPN differential pair and the PNP pair becomes inactive for the rest of the input common mode range up to the positive supply.

The input offset voltage and the input bias current are dependent on which input stage is active. The input offset voltage is trimmed on a single 5V supply with the common mode at 1/2 supply and is typically 1mV with the PNP stage active. The input offset of the NPN stage is untrimmed and is typically 1.5mV. The input bias current polarity depends on the input common mode voltage. When the PNP differential pair is active, the input bias currents flow out of the input pins. They flow in the opposite direction when the NPN input stage is active. The offset error due to the input bias currents can be minimized by equalizing the noninverting and inverting source impedance.

The input stage of the LT1797 incorporates phase reversal protection to prevent false outputs from occurring when the inputs are driven up to 5V beyond the rails. Protective resistors are included in the input leads so that current does not become excessive when the inputs are forced beyond the supplies or when a large differential signal is applied.

Output

The output is configured with a pair of complementary common emitter stages Q19/Q20, which enable the output to swing from rail-to-rail. The output voltage swing of the LT1797 is affected by input overdrive as shown in the Typical Performance Characteristics. When monitoring input voltages within 50mV of V^+ or within 8mV of V^- , some gain should be taken to keep the output from clipping. The output of the LT1797 can deliver large load currents; the short-circuit current limit is typically 50mA at $\pm 5V$. Take care to keep the junction temperature of the IC below the absolute maximum rating of 150°C. The output of the amplifier has reverse biased diodes to each supply. If the output is forced beyond either supply, unlimited current will flow through these diodes.

The LT1797 can drive capacitive loads up to 200pF on a single 5V supply in a unity gain configuration. When there is a need to drive larger capacitive loads, a resistor of a couple hundred ohms should be connected between the output and the capacitive load. The feedback should still be taken from the output so that the resistor isolates the capacitive load to ensure stability. The low input bias current of the LT1797 makes it possible to use high value feedback resistors to set the gain. However, care must be taken to insure that the pole formed by the feedback resistors and the total capacitance at the inverting input does not degrade stability.

APPLICATIONS INFORMATION

Distortion

There are two main contributors to distortion in op amps: output crossover distortion as the output transitions from sourcing to sinking current and distortion caused by nonlinear common mode rejection. If the op amp is operating in the inverting mode, there is no common mode induced distortion. If the op amp is operating in the PNP input stage (input is not within 1.2V of V^+), the CMRR is

very good, typically 95dB. When the LT1797 switches between input stages there is significant nonlinearity in the CMRR. Lower load resistance increases the output crossover distortion, but has no effect on the input stage transition distortion. For lowest distortion the LT1797 should be operated single supply, with the output always sourcing current and with the input voltage swing between ground and $(V^+ - 1.2V)$. See the Typical Performance Characteristic curves.

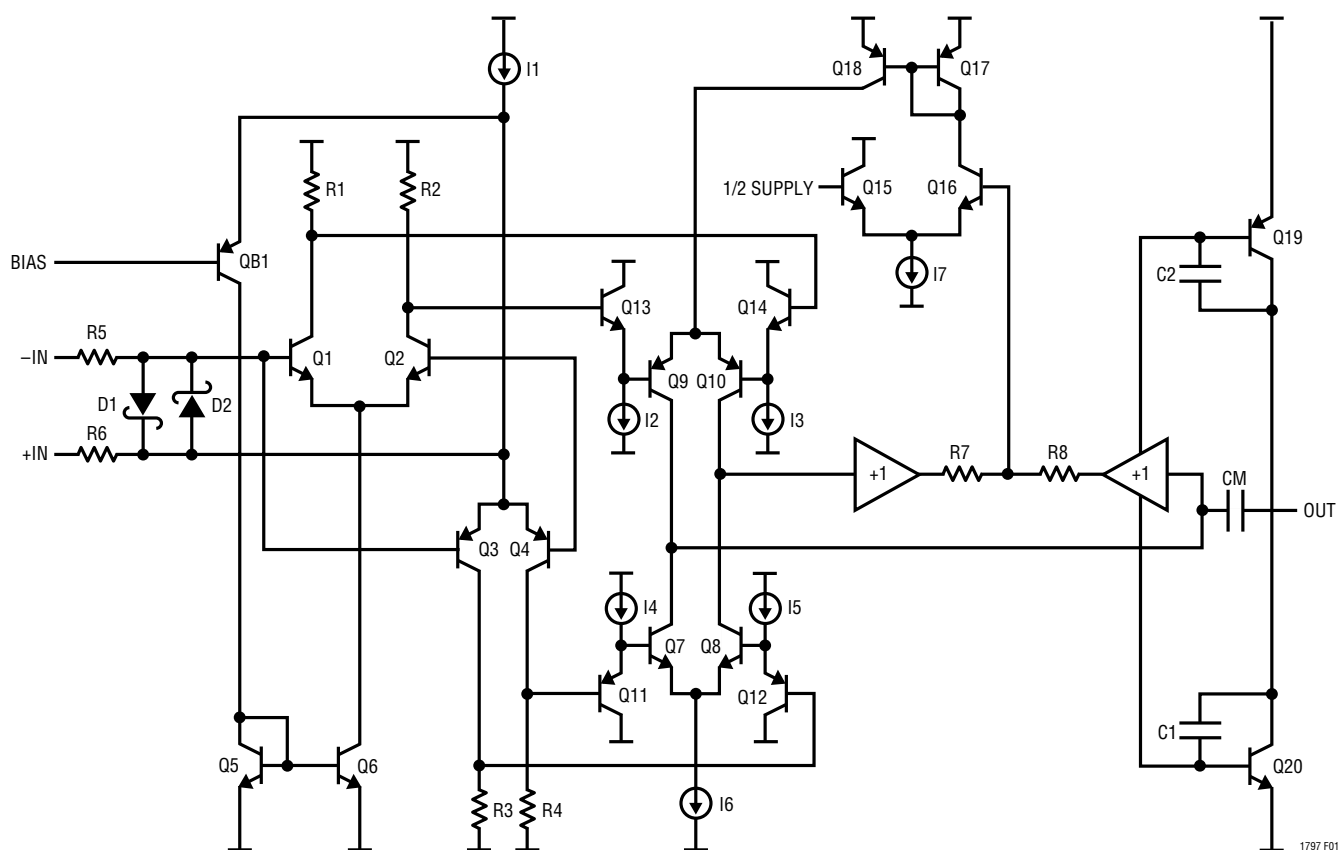
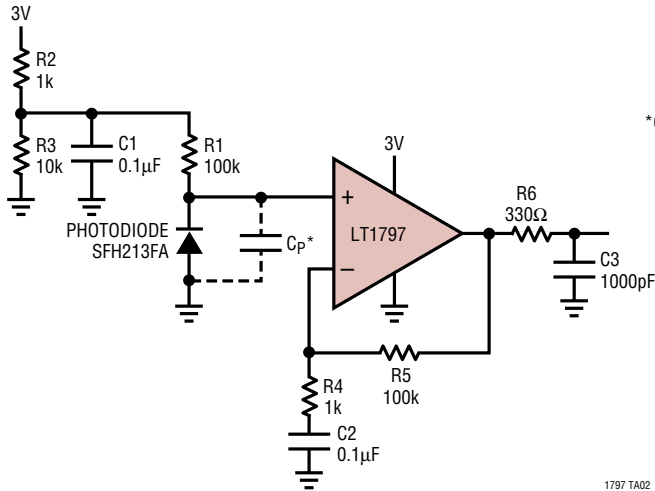

Figure 1. Simplified Schematic

TYPICAL APPLICATIONS

Single Supply Hi-Gain 80kHz Photodiode Amplifier



*C_p = SUM OF PHOTODIODE CAPACITANCE, PARASITIC LAYOUT CAPACITANCE AND LT1797 INPUT CAPACITANCE ≈ 10pF.

TRANSIMPEDANCE GAIN: A_Z = 10MΩ.

R6, C3 LIMIT THE NOISE BANDWIDTH TO 500kHz.

OUTPUT NOISE ≈ 1.8mV_{RMS}.

R1, C_p AND LT1797 GBW SET UPPER LIMIT ON BANDWIDTH.

R4, C2 SET LOWER 1.6kHz LIMIT ON GAIN OF 101.

1797 TA02

Ultra-Low Noise, ±5V Supply, Rail-to-Rail Output Amplifier

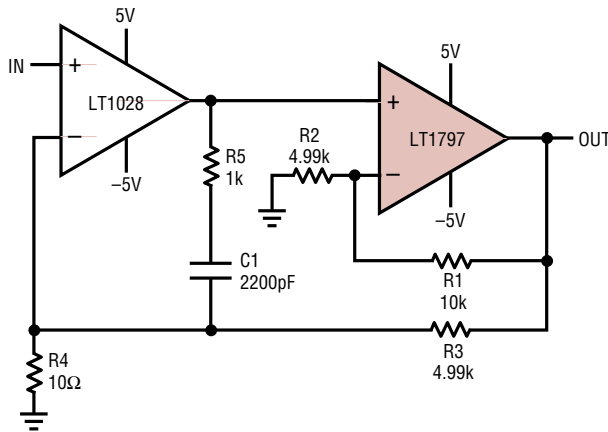

TOTAL INPUT VOLTAGE NOISE ≈ 0.94nV/√Hz (INCLUDING 10Ω RESISTOR)

BANDWIDTH ≈ 40kHz

A_v = 500

1797 TA03

PACKAGE DESCRIPTION Dimensions in inches (millimeters) unless otherwise noted.

S5 Package
5-Lead Plastic SOT-23
 (LTC DWG # 05-08-1633)

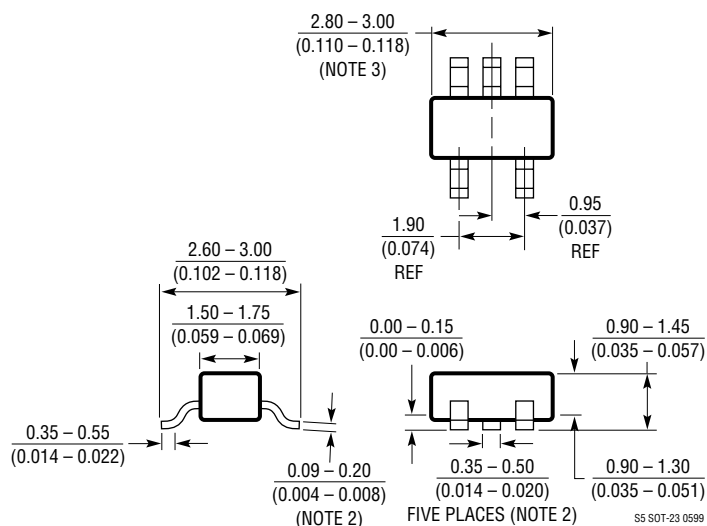

- NOTE:
1. DIMENSIONS ARE IN MILLIMETERS
 2. DIMENSIONS ARE INCLUSIVE OF PLATING
 3. DIMENSIONS ARE EXCLUSIVE OF MOLD FLASH AND METAL BURR
 4. MOLD FLASH SHALL NOT EXCEED 0.254mm
 5. PACKAGE EIAJ REFERENCE IS SC-74A (EIAJ)

TYPICAL APPLICATION

1MHz Photodiode Transimpedance Amplifier

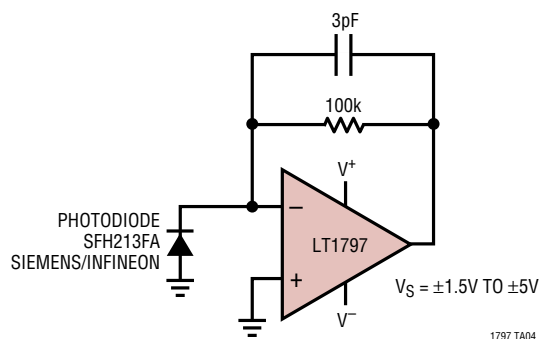

Response of Photodiode Amplifier

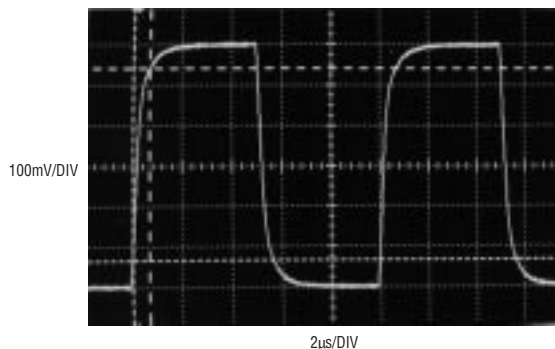

Rise Time vs Supply Voltage (600mV Output Step)

| Supply Voltage | 10% to 90% Rise Time |
|----------------|----------------------|
| ±1.5V | 830ns |
| ±2.5V | 800ns |
| ±5V | 700ns |

RELATED PARTS

| PART NUMBER | DESCRIPTION | COMMENTS |
|---------------|---|--|
| LT1630/LT1631 | Dual/Quad 30MHz, 10V/µs Rail-to-Rail Input and Output Op Amps | High DC Accuracy, 525µV $V_{OS(MAX)}$, 70mA Output Current, Max Supply Current 4.4mA per Amp |
| LT1638/LT1639 | Dual/Quad 1.2MHz, 0.4V/µs, Over-The-Top™ Micropower Rail-to-Rail Input and Output Op Amps | 170µA Supply Current, Single Supply Input Range -0.4V to 44V, Rail-to-Rail Input and Output. |
| LT1783 | Micropower Over-The-Top SOT-23 Rail-to-Rail Input and Output Op Amp | SOT-23 Package, Micropower 220µA per Amplifier, Rail-to-Rail Input and Output, 1.2MHz Gain Bandwidth |
| LT1880 | SOT-23 Rail-to-Rail Output, Picoamp Input Current Precision Op Amp | 150mV Maximum Offset Voltage, 900pA Maximum Bias Current, 1.1MHz Gain Bandwidth, -40°C to 85°C Temperature Range |

Over-The-Top is a trademark of Linear Technology Corporation.